

REACH RIDER STACKER

EPS AC

AC POWERED ELECTRIC RIDER 3,000-4,000LB



Single & Double Reach



ESRRACX-EPS

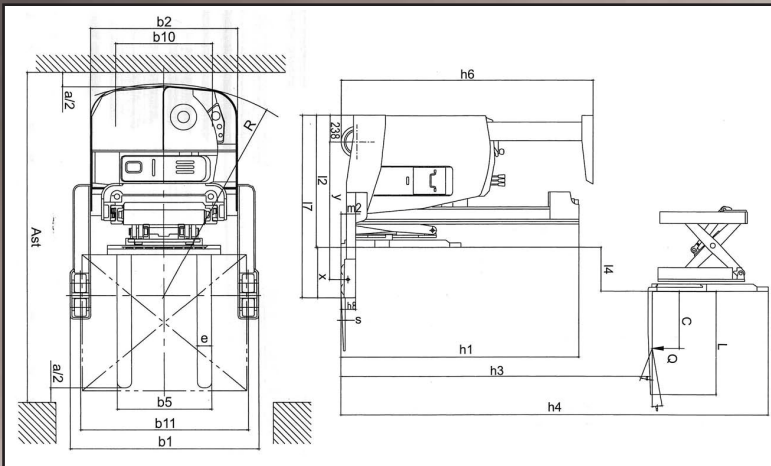

			30	35	40	30	35	40
			2 STAGE MAST			3 STAGE MAST		
Characteristics	Load capacity	LBS	3000	3500	4000	3000	3500	4000
	Drive / Operation type	Type	Electric - Rider			Electric - Rider		
	Load centre distance	IN	24			24		
	Wheel number, front/rear (x = driving wheel)	#	1+2			1+2		
	Tread, front	IN	26.5			26.5		
	Tread, rear	IN	44.9			44.9		
	Wheels	Type	polyurethane			polyurethane		
	Wheel dimension, front	IN	11.0 x 3.2 + 6.3 x 2.4 (2)			11.0 x 3.2 + 6.3 x 2.4 (2)		
	Wheel dimension, rear	IN	4.9 x 3.2 (4)			4.9 x 3.2 (4)		
	Wheelbase	IN	51.9			57.8		
Tilt of mast/fork carriage forward/backward	DEG	2/5			2/5			
Dimensions	Max. lift height	IN	118.1 / 137.8 / 157.5			177.2 / 196.9 / 216.5 / 236.2 / 255.9		
	Mast height, extended	IN	153.5 / 173.2 / 192.9			212.6 / 232.3 / 252.0 / 271.7 / 291.3		
	Free Lift Height	IN	-			69.9 / 69.9 / 79.1 / 81.9 / 88.2		
	Ground Clearance	IN	1.9			1.9		
	Mast height, lowered	IN	103.0	83.7 / 93.5 / 103.3	106.9	103.0	86.0 / 92.3 / 98.6 / 105.3 / 111.0	106.9
	Overall length	IN	106.9			106.9		
	Overall width	IN	51.0 / 40.9			40.9 - 51.5		
	Fork dimension	IN	1.6 x 3.9 x 42.0			1.6 x 3.9 x 42.0		
	Fork length	IN	42.0			42.0		
	Fork width	IN	3.9			3.9		
	Straddle Width	IN	6.6			6.6		
	Inside Straddle width	IN	38.3			38.3		
	Outside Straddle width	IN	116.4	51.5	118.6	116.4	51.5	118.6
	Aisle width, with pallet 39"x47" crosswise	IN	119.2	118.6	121.5	119.2	118.6	121.5
	Aisle width, with pallet 32"x47" lengthwise	IN	70.5	121.5	72.8	70.5	121.5	72.8
Turning radius	IN	72.8			72.8			
Battery box dimension (LxWxH)	IN	38.9 x 16.0 x 21.7			38.9 x 16.0 x 31.7			
Battery weight	LBS	1122			1782			
Service weight (with battery)	LBS	6886 / 6996 / 7106	7282 / 7392 / 7502	7403 / 7513 / 7623	7414 / 7634 / 7854 / 8074 / 8294	7810 / 8030 / 8250 / 8470 / 8690	7931 / 8151 / 8371 / 8591 / 8811	
Performance	Traveling speed, laden/unladen	MPH	4.0 / 4.3			4.0 / 4.3		
	Lifting speed, laden/unladen	IN/S	7.9 / 11.8			7.9 / 11.8		
	Lowering speed, laden/ unladen	IN/S	12.6 / 12.2			12.6 / 12.2		
	Max. gradeability, laden/unladen	%	5 / 12			5 / 12		
Driving System	Battery type		Industrial			Industrial		
	Battery voltage/rated capacity	v/Ah	36 / 490			36 / 700		
	Charger, 110v plug-in	Type	Off Board			Off Board		
	Driving motor power	HP	4.0 (AC)			4.0 (AC)		
	Lifting motor power	HP	13.4			13.4		
	Control system	Type	Curtis 1234			Curtis 1234		
Service brake	Type	Electromagnetic			Electromagnetic			

*All models are also available with Double Reach.



REACH RIDER STACKER

EPS AC

AC POWERED ELECTRIC RIDER 3,000-4,000LB

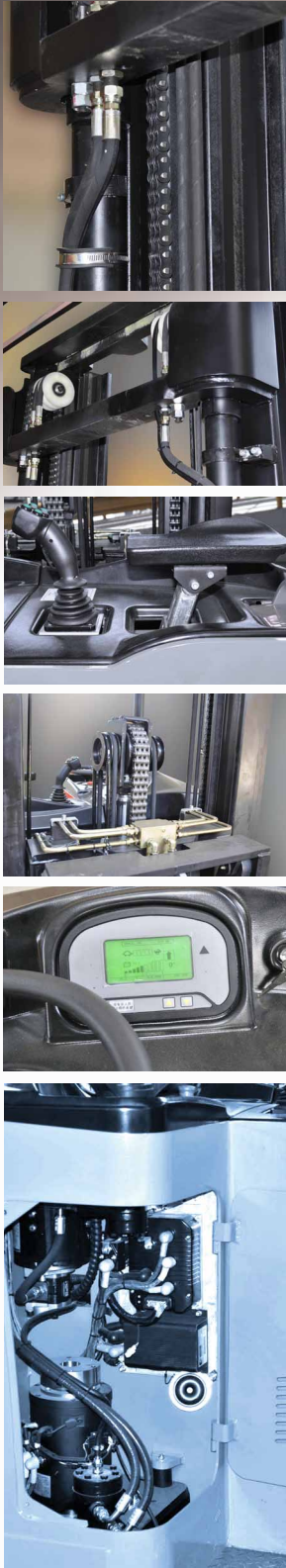

Models: ESRR30-35-40ACX-EPS FEATURES

- Optional electric power steering for easy handling
- Advanced AC control system
- Stepless speed control
- Regenerative braking system
- Equipped with adjustable hand rest, adaptable to fit different operators
- Large cab area for operator comfort
- Multi-function display: battery status, hour meter, fault indicator, etc.
- Dampening materials make for quieter operation
- Built-in pressure relief valve
- Emergency power disconnect
- Low centre of gravity ensures stability
- Vertical driving wheel for small turning radius
- Motor structure is water and dust proof
- Convenient roll out battery system for easy replacement
- Accessible back cover make maintenance and adjustments trouble free
- Low maintenance design

OPTIONAL

- Deep/Double reach
- Sideshift
- Straddle legs with options
- Double front wheels

